

Compact Port 15

Underwater Lens Port

Please follow the instructions below to mount the Compact Port 15 on the Compact Port Base.

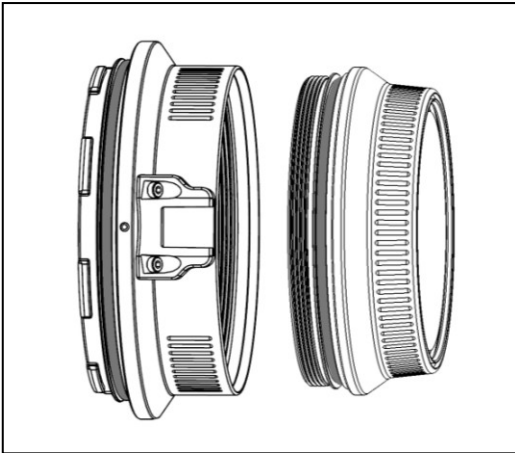

1. Remove the O-ring from the compact port, inspect for any damage and lightly coat it with the provided lubricant before placing it back into its groove.
2. Verify that the threaded section of the port base is clean and free from foreign material.
3. Align the external threaded section of the compact port and the internal threaded section of the port base.

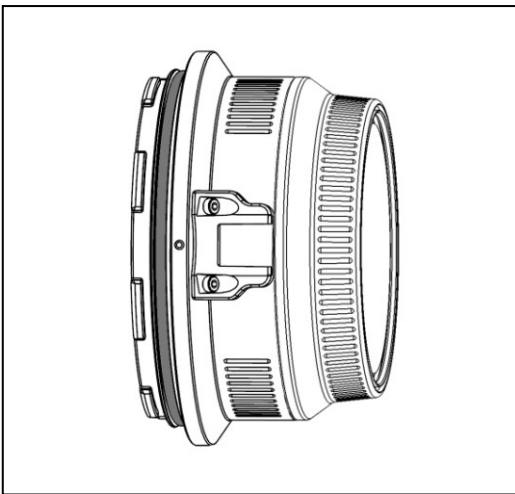

4. Attach the compact port on the port base by holding the port base firmly and turning the compact port clockwise until there is no gap between the two.
5. To detach the compact port from the port base, turn the compact port anti-clockwise while holding the port base firmly.

Please refer to the instruction manual of the housing for guidelines to install the camera and the lens into the housing and port system.